

**PREINSTALLATION
VORINSTALLATION**

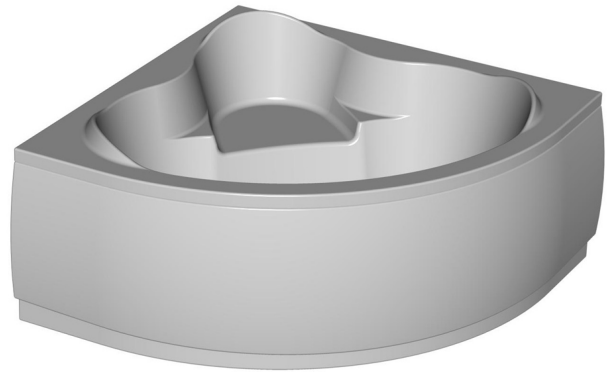
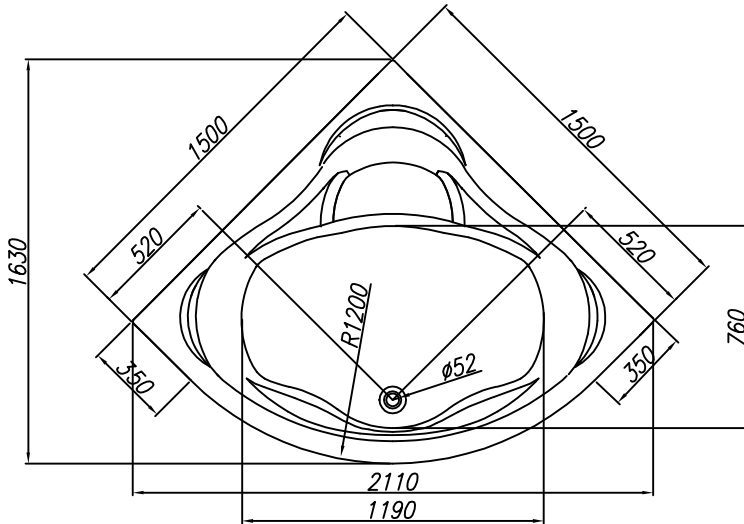
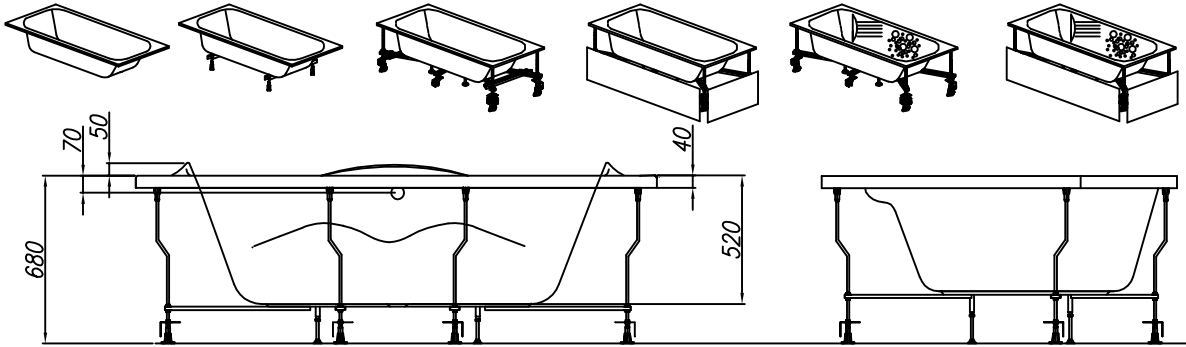

VOLUME (l)	MAX. LOAD (kg)	FLOOR LOAD (kg/m ²)
VOLUMEN (l)	MAX. BELASTUNG (kg)	BODENBELASTUNG (kg/m ²)

385

560

290

- - Spot for el. cable 3×2.5mm², length approx. 1m
- Platz Stromkabel 3 × 2,5 mm², Länge cca. 1 m
- - Spot for el. cable 1×6mm² for earthing, length approx. 1.5m
- Platz Stromkabel 1 × 6 mm² für Erdung, Länge cca. 1,5 m

- ⊠ - Connection of hot and cold water 1/2" min 0.2Mpa, max 0.4Mpa
- Anschluss Warm- und Kaltwasser 1/2" min 0,2 Mpa, max 0,4 Mpa

- - Drain spot Ø 50mm
- Abflussplatz Ø 50 mm

- ▨ - Panel - option
- Möglichkeit - Schürze

**INSTALLATION RECOMMENDATION
MONTAGEEMPFEHLUNG**

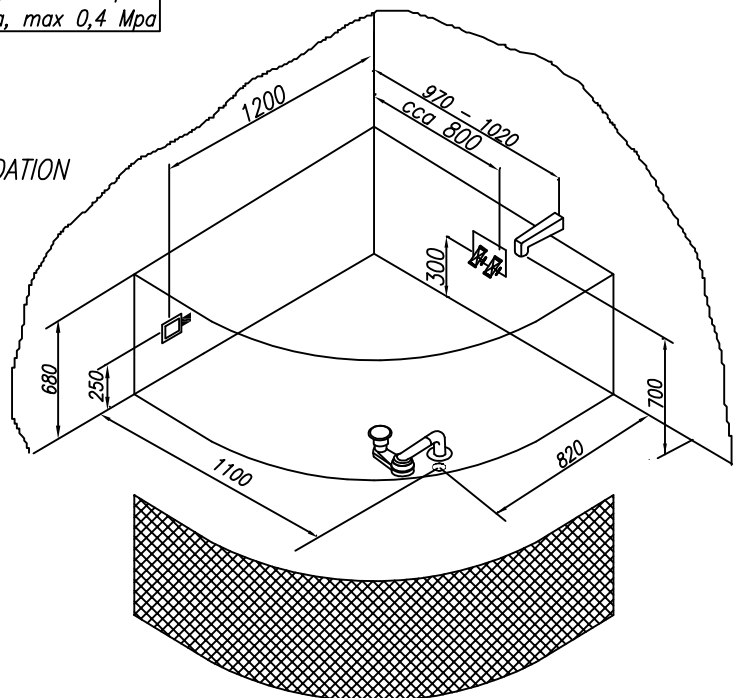

Recommended overflow set Vorgeschlagene Überlaufgarnitur	PAL 650
Recommendations for the installation of bathtub without panel Empfehlungen für die Montage von Badewannen ohne Schürze	Nr. MK 02
Recommendations for the installation of bathtub with panel Empfehlungen für die Montage von Badewannen mit Schürze	Nr. MK 01
Option of the built-in bathtub base Möglichkeit des Sockels für die Badewannen ohne Schürze	Nr. MK 06 1001/B
Option of the bathtub base with panel Möglichkeit des Sockels für die Badewannen mit Schürze	Nr. MK 17 CKM 120-150

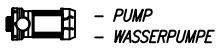

- PUMP
- WASSERPUMPE

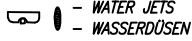

- WATER JETS
- WASSERDÜSEN



- AIR CONTROLLER
- LUFTREGLER

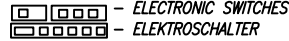

- ELECTRONIC SWITCHES
- ELEKTROSCHALTER



- FIXTURE AND SHOWER HANDLE
- WASSERHAHN UND DUSCHE

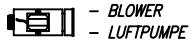

- BLOWER
- LUFTPUMPE



- AIR JET
- LUFTDÜSE



- PNEUMATIC SWITCH
- PNEUMATIKSCHALTER



- LIGHT OR CHROMOTHERAPY
- LICHT- ODER CHROMOTHERAPIE



- MICROJET SWITCH
- SCHALTER FÜR MIKRODÜSEN

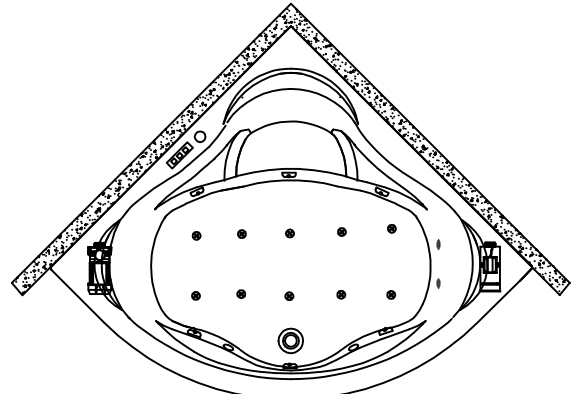
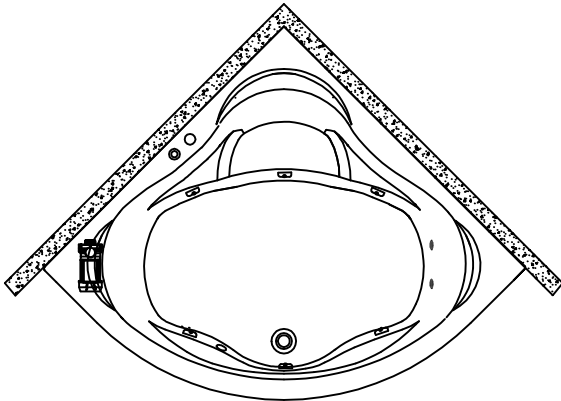

WATER MASSAGE SYSTEM 1 WASSERMASSAGESYSTEM 1

- PUMP P=800W
- PNEUMATIC SWITCH
- AIR CONTROLLER
- 6 WATER JETS
- 2 MICROJETS FOR FEET

- WASSERPUMPE P = 800 W
- PNEUMATIKSCHALTER
- LUFTREGLER
- 6 WASSERDÜSEN
- 2 MIKRODÜSEN FÜR FÜSSE

WATER AND AIR MASSAGE SYSTEM

- PUMP P=1250W
- BLOWER P=800W
- ELECTRONIC SWITCH
- 6 SUPER WATER JETS
- 10 AIR JETS
- 2 MICROJETS FOR FEET
- AIR REGULATOR

WASSER UND LUFT MASSAGESYSTEM

- WASSERPUMPE P = 1250 W
- BLOWER P=800W
- ELEKTROSCHALTER
- 6 SUPER-WASSERDÜSEN
- 10 LUFTDÜSEN
- 2 MIKRODÜSEN FÜR FÜSSE
- LUFTREGLER

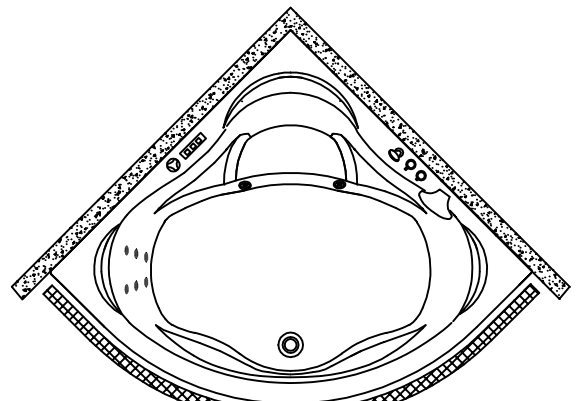
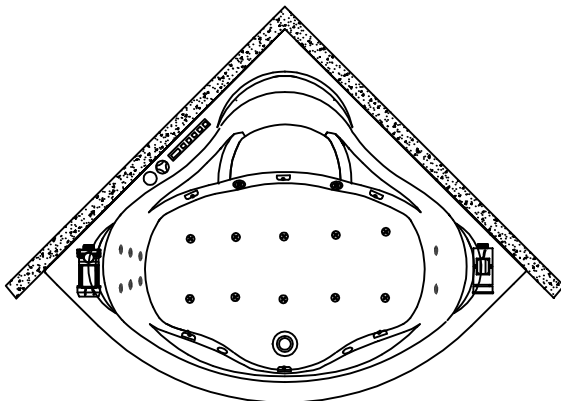

VITAL MASSAGE SYSTEM

- PUMP P=1250W
- BLOWER P=800W
- HEATER P=1500W
- ELECTRONIC SWITCH
- AIR CONTROLLER
- 6 SUPER WATER JETS
- 10 AIR JETS
- OZONE FOR DISINFECTION
- CHROMOTHERAPY
- 6 MICROJETS FOR BACK
- 2 MICROJETS FOR FEET

VITAL MASSAGESYSTEM

- WASSERPUMPE P = 1250 W
- LUFTPUMPE P = 800 W
- HEIZKÖRPER P = 1500 W
- ELEKTROSCHALTER
- LUFTREGLER
- 6 SUPER-WASSERDÜSEN
- 10 LUFTDÜSEN
- OZON FÜR DESINFEKTION
- CHROMOTHERAPIE
- 6 MIKRODÜSEN FÜR RÜCKEN
- 2 MIKRODÜSEN FÜR FÜSSE

- OPTION FIXTURE AND SHOWER HANDLE - MÖGLICHKEIT WASSERHAHN UND DUSCHE

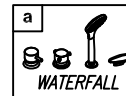
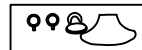

- OPTION 6 MICROJETS P=1250W



- MÖGLICHKEIT MIKRODÜSEN 6 P = 1250 W



- MÖGLICHKEIT CHROMOTHERAPIE



- OPTION CHROMOTHERAPY

- MÖGLICHKEIT CHROMOTHERAPIE



- OPTION PANEL FOR BATHTUB

- OPTION SHÜRZE FÜR BADEWANNE

